

**Plow Mount Parts**

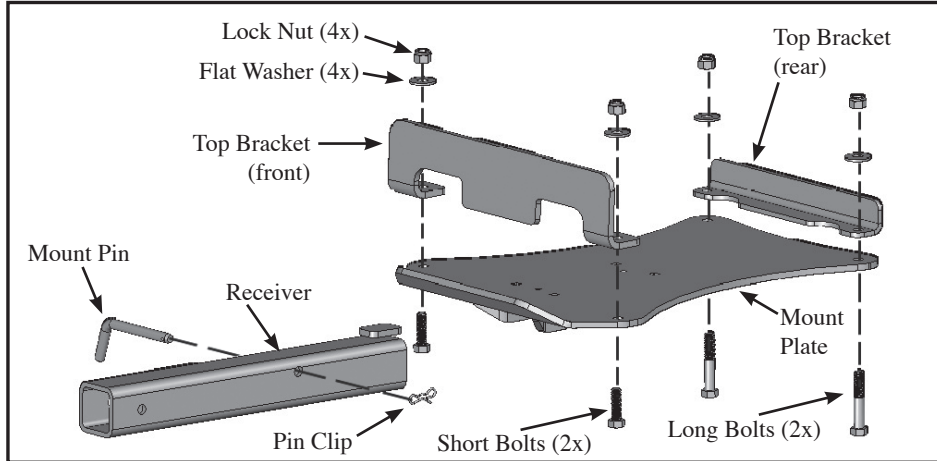

**Tools:** 9/16 wrench (2)  
 Ft. lbs. torque wrench with 9/16 socket  
 Protective eyewear

**1**

a) Position rear bracket with rear of mount plate as shown and assemble with one long bolt, flat washer and lock nut, turn finger tight. **(NOTE: Notched side of rear bracket points down facing towards front)**

b) From side of machine at front of frame, orientate front bracket as shown and insert it across top of frame.

c) When done, bracket should nestle on top of machine frame as shown.

**2**

a) Under rear of machine, from side as shown insert rear bracket on mount plate across top of rear frame tubes (and under drive shaft) until open hole in bracket extends on outside of frame on opposite side.

b) Then insert another long bolt bottom up through mount plate and into rear bracket, place flat washer and turn lock nut finger tight. (Photo taken from left side of machine)

c) Shows rear bracket nestled on top of rear frame and under drive shaft with nuts finger tight on both sides. (Photo taken from right side of machine)

**(continued on back)**

(continued from front)

3

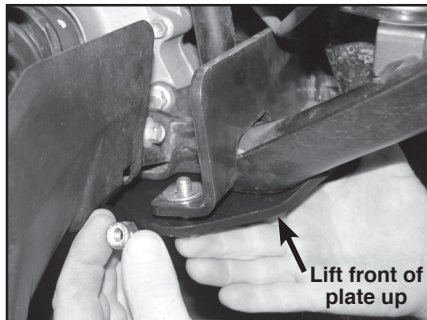

a) At front of machine, lift front of mount plate up and insert short bolt bottom up through mount plate and into hole on front bracket. Then use flat washer and turn lock nut on finger tight. Insert another short bolt, flat washer and finger tight lock nut on opposite side.

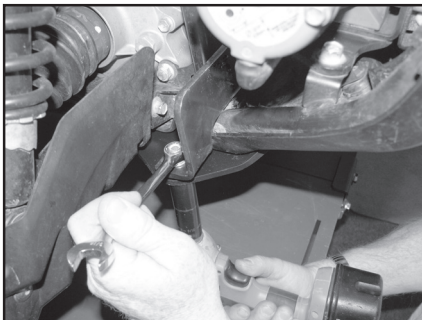

b) Using 9/16 wrenches, tighten both front bolts snug tight for now.

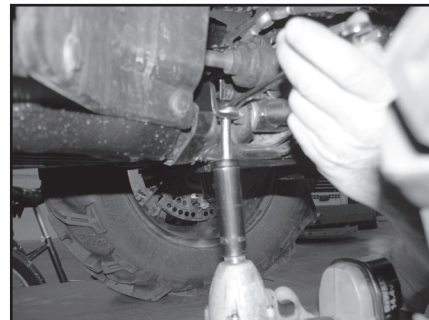

c) Then tighten both rear bolts snug tight. (9/16 size wrenches) **Now torque each front bolt to 31 ft. lbs. Then torque each rear bolt to 31 ft. lbs.**

4

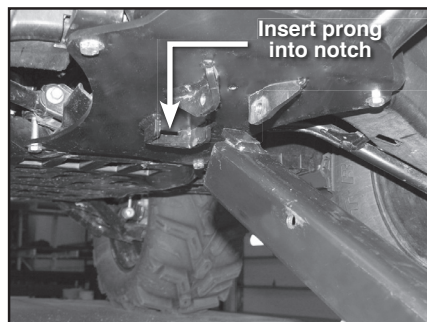

a) Insert rear prong on receiver tube into notch on rear of mount plate.

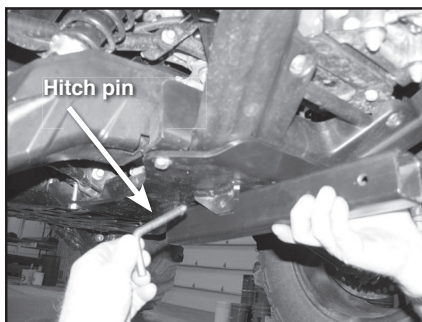

b) Lift front of receiver up and insert receiver pin through holes of receiver and mount plate.

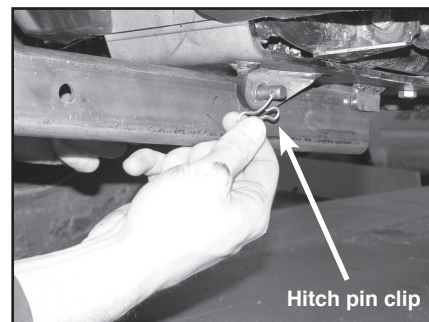

c) Insert hitch pin clip into receiver pin. Installation is now complete. Periodically check bolts and retorquer if needed.