



2009-18 RAM 1500, 2019-20 CLASSIC & 2010-19 2500/3500 INSTALLATION INSTRUCTIONS

Thank you for purchasing ROCKSTAR™ Splash Guard Mud Flaps. Agri-Cover, Inc. proudly manufactured these mud flaps using superior quality materials and workmanship. With proper care, your mud flaps will provide years of service and enjoyment.

NOTICE TO INSTALLER: Even if familiar with mud flaps, read instructions prior to installation as improvements may be made without notice. Always handle components with care. If you have questions or problems, call customer service. When done, these instructions must be given to the consumer.

NOTICE TO CONSUMER: Before using this product, read safety and maintenance section of these instructions. Save these instructions for future reference.

FOR YOUR RECORDS

DATE PURCHASED: _____

WHERE PURCHASED: _____



Questions? 888-568-3709
agricover.com

PREPARATION

Unpack set of two mud flaps with components. Clean vehicle wheel wells. For additional installation assistance, go to rockstarmudflaps.com for install video.

MUD FLAP COMPONENTS

- (2) Mud flaps
- (8) #10 x 1-1/4" Self-drilling hex screws
- (8) #10 x 1/2" Washers
- (2) #8-32 Hex nuts
- (2) Stabilizing brackets

TOOLS NEEDED

- Angled drill/screwdriver
- Ratchet
- 5/16" and 7 mm sockets
- Protective eyewear

NOTE: Hardware components and appearance may vary.

▲ CAUTION: These instructions involve drilling holes. Ensure all mounting hole sides are free of wiring, mechanical parts and are structurally sound.

PARTS & FASTENER MOUNTING DIAGRAM

NOTE: Mud flaps may be purchased with or without pre-installed trim plates (not pictured). Trim plates are also available for purchase as an accessory.

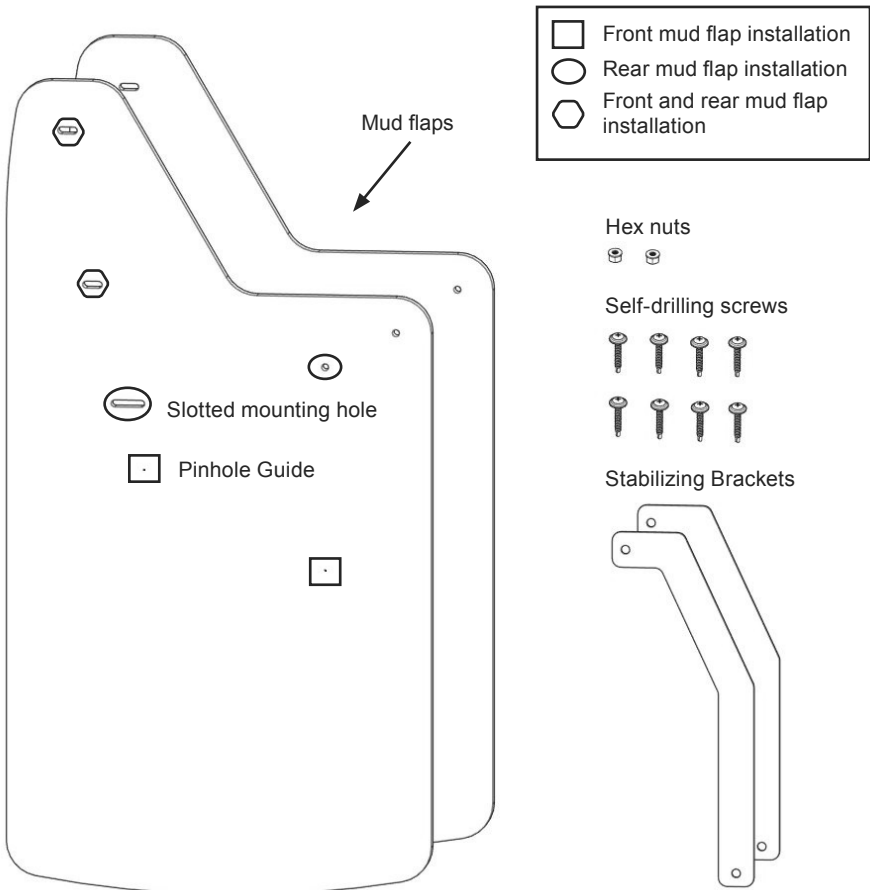

1. PREPARING FOR INSTALLATION

A. Park on level ground with firm surface.

B. Check free space behind front tires when fully turned. Ensure enough space and clearance to accommodate 5/16" thick mud flaps.



NOTE: If trim plates are pre-installed, face them toward tailgate during installation

C. To install mud flaps, perform one of the following:

- See Step 2 for front wheel well installation
- See Step 3 (page 6) for rear wheel well installation

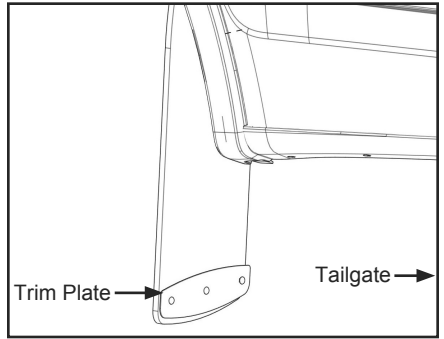

2. INSTALLING MUD FLAPS TO FRONT

NOTE: Front mud flap installation uses 4 holes per mud flap, see PARTS DIAGRAM (page 2) for locations.

A. Remove indicated factory screw and washer with 7 mm socket.



2. INSTALLING MUD FLAPS TO FRONT (Continued)

B. Attach mud flap to wheel well with factory hardware using existing hole.



C. Level mud flap while adjusting in and out to obtain best fit then tighten factory screw to hold in place.

D. Install #10 x 1-1/4" self-drilling screw with washer to indicated upper slotted mounting hole.

E. Install (2) #10 x 1-1/4" self-drilling screws with washers at indicated pinhole guides.

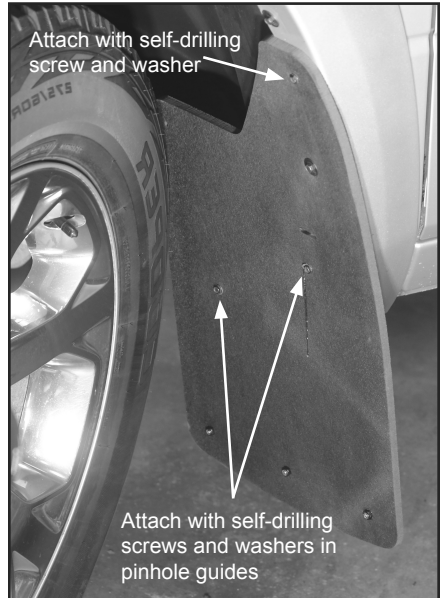

2. INSTALLING MUD FLAPS TO FRONT (Continued)

F. From behind the mud flap, determine the stabilizing bracket mounting position. Stabilizing bracket should attach to the protruding screw and to vehicle body.

NOTE: The stabilizing bracket is often used to pull back front mud flap for additional tire clearance or square mud flap with tire. The example provided shows one possibility and may vary depending on vehicle.

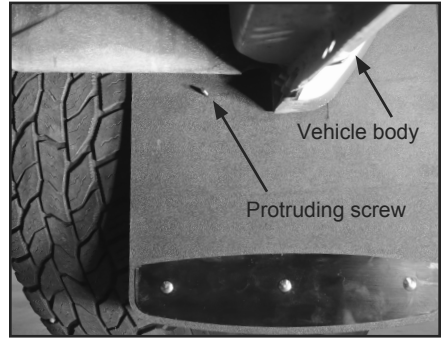

G. Use locking pliers to bend stabilizing bracket as needed.

NOTE: Ensure bends in stabilizing bracket conform to mounting locations before attaching to mud flap and vehicle.



H. Attach bracket to protruding screw and secure with a #8-32 hex lock nut.

I. Adjust stabilizing bracket until enough clearance is provided in wheel well.

J. Attach free end of stabilizing bracket to vehicle with #10 x 1-1/4" self-drilling screw.

K. Repeat for remaining front mud flap.

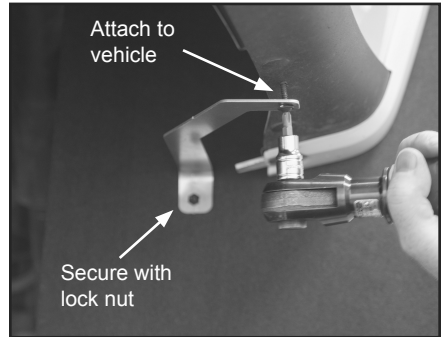

3. INSTALLING MUD FLAPS TO REAR

NOTE: Rear mud flap installation uses 4 holes per mud flap, see PARTS DIAGRAM (page 2) for locations.

A. Remove factory indicated screws and washers with 7 mm socket.

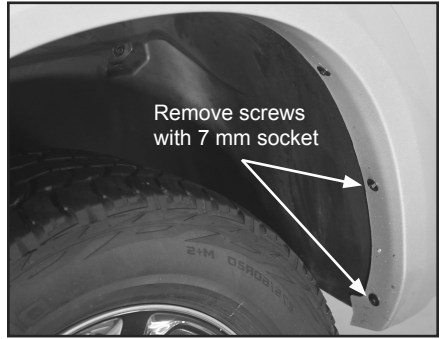

B. Attach mud flap to wheel well with factory hardware using existing holes.

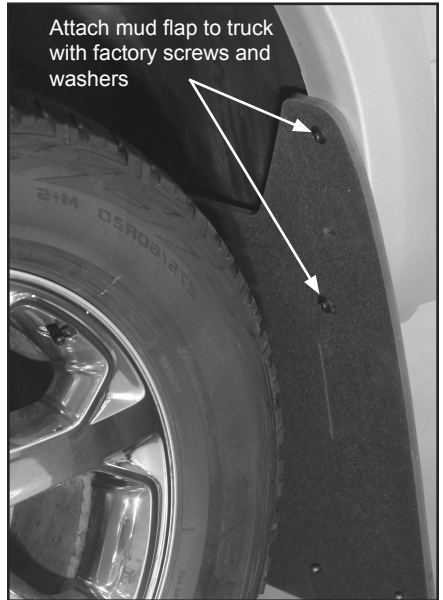

3. INSTALLING MUD FLAPS TO REAR (Continued)

C. Level mud flap while adjusting placement to obtain best fit then tighten screws to hold in place.

D. Install #10 x 1-1/4" self-drilling screw with washer at upper slotted mounting hole.

E. Install #10 x 1-1/4" self-drilling screw with washer at indicated pinhole guide. Then secure with nut.

F. Repeat for remaining rear mud flap.

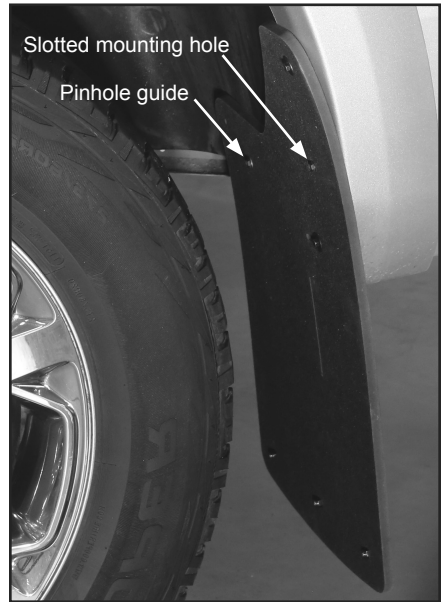

SAFETY AND MAINTENANCE

The operator can perform most of inspection and maintenance. It may be necessary to review the installation instructions.

- Periodically check all screws, washers and nuts, retighten if needed.
- If mud flap has been damaged, replace with new one.

NOTE: Inspection and/or maintenance should be performed anytime a malfunction is observed or suspected. If you need assistance inspecting and/or servicing your mud flaps, call customer service at 888-568-3709. Always use original equipment replacement parts for your mud flaps.

MANUFACTURER'S LIMITED WARRANTY

Agri-Cover, Inc. extends the following (1) year Limited Warranty for the ROCKSTAR™ Splash Guard Mud Flaps:

Agri-Cover, Inc. warrants a period of one (1) year from the date of manufacture that its ROCKSTAR™ Splash Guard Mud Flaps are free from defects in workmanship, under normal use for the truck model it was intended for. This Limited Warranty does not cover any damage due to accident, abuse, misuse, alteration, neglect, improper installation, or ordinary wear and tear.

Agri-Cover, Inc.'s sole obligation under this Limited Warranty is limited to the repair or replacement at its option, of defective parts only. No labor or service allowance is given or implied. IN NO EVENT SHALL AGRI-COVER, INC. BE LIABLE FOR INCIDENTAL, CONSEQUENTIAL, OR SPECIAL DAMAGES. AGRI-COVER, INC. EXPRESSLY DISCLAIMS ANY AND ALL IMPLIED WARRANTIES OF MERCHANTABILITY, AND THERE ARE NO WARRANTIES WHICH EXTEND BEYOND THE LIMITED WARRANTY DESCRIPTION CONTAINED HEREIN.

For warranty, have serial number ready and fill out the warranty claim form at agricover.com/warrantyclaim or call Customer Service Department at 888-568-3709 to determine if only a replacement part is needed or if the mud flaps needs to be returned for inspection and repair. Goods to be returned must have a pre-authorized RA # (Return Authorization Number) - obtained by calling the number above. Mark the number on the package and ship it freight prepaid to address below. Agri-Cover, Inc. will pay freight to return goods to sender.

This Limited Warranty gives you specific legal rights and you may have other rights, which vary, from state to state.

For replacement parts shop at rockstarmudflaps.com or call Customer Service at 888-568-3709.



Agri-Cover, Inc.
Customer Service Dept
3000 Hwy 281 SE
Jamestown, ND 58401
Phone: 888-568-3709

Hours: 8:00 am - 5:00 pm CST Monday through Friday, except Holidays